

Mito sospeso 60 fix flat datasheet

Annular LED suspended luminaire with double-sided light emission and a diameter of 60 cm. There is a choice of two lighting effects. table (wide) for use over tables – wide light beam downwards and upwards. room (narrow) for freely suspended luminaire lighting – concentrated light beam directed downwards, diffused light directed upwards. The maximum suspension length is 350 cm (can be adjusted during fitting).

Version for hollow ceilings with embedded suspension wires and cover for fitting and inspecting the power supply unit. Can be controlled via »touchless control« (gesture control on the head), Occhio air or DALI; alternatively, dimmable via a trailing-edge phase cut dimmer*. Connection to 230V AC mains voltage. The color temperature can be continuously controlled via »touchless control«, Occhio air or DALI from 2700 to 4000K or can be preset (2700/3000/3500/4000 K).

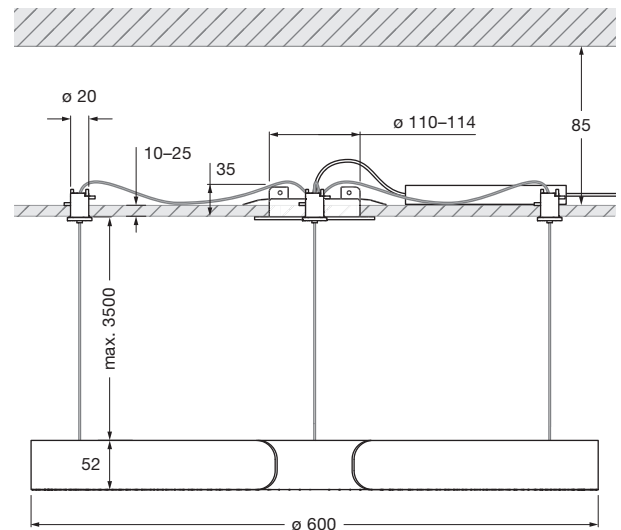

incl. power supply unit (removable)
dimensions: L 170 x W 89 x H 27

dimensions in mm

technical data Mito sospeso 60 fix flat

properties	material	aluminium, painted, PVD-coated steel, plastic, optical silicone
	height setting	max. 3500 mm (can be adjusted during fitting)
	weight	3.15 kg
surface	head	bronze, matt gold, rose gold, matt silver, matt white, matt black, phantom, black phantom
	canopy	matt white, matt black
Occhio »color tune« LED	average life time	> 50.000 hrs
	energy efficiency class (luminous efficiency)	G (59 lm / W)
	power	LED 60 W (incl. Occhio power supply unit approx. 66 W, standby < 0.5 W)
	color rendering index	high color; CRI Ra 95
	color temperature (color consistency)	2700–4000 K (2-step)
electricity	dimming	»touchless control«, Occhio air (optional), DALI or via trailing-edge phasecut dimmer*
	connection	230V AC
	power factor power supply (cos ϕ 1)	0.9
	flicker / stroboscopic effect	1 (PstLM) / 0.9 (SVM)
	permitted operating conditions	max. 30°C for indoor use only

* For a list of compatible dimmers, see www.occhio.de/dim_en, trailing-edge phasecut dimmer, Occhio air and DALI not combinable

Mito sospeso 60 fix flat lighting effects

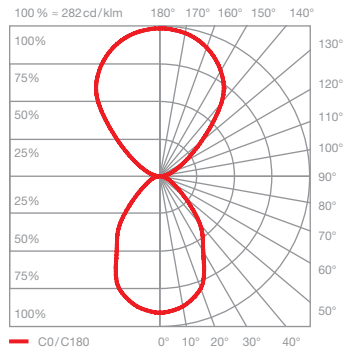
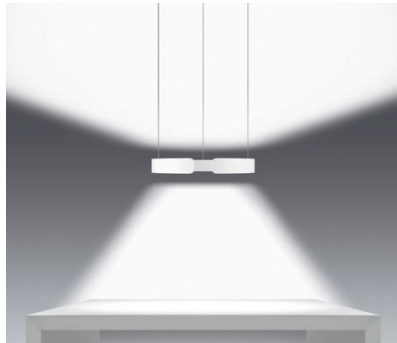

table (wide)

wide light beam (up and down), beam angle approx. 80° (down)

inserts: wide / flood

luminous flux : high color 60 W 3330 lm

UGR (4H8H) < 19

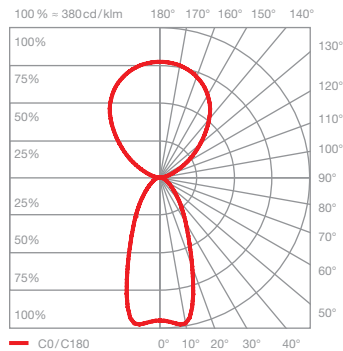
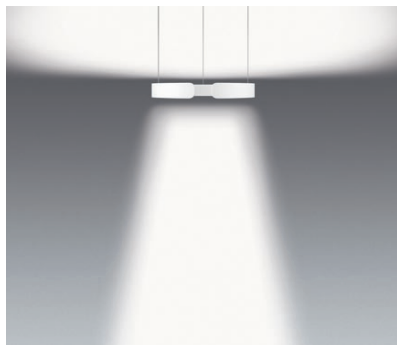

room (narrow)

concentrated light downwards, beam angle approx. 50°, diffuse upwards

inserts: narrow / diffuse

luminous flux : high color 60 W 3210 lm

UGR (4H8H) < 19

control options

Control

Mito set box

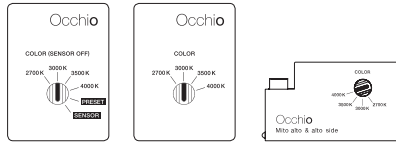

sospeso / aura / sfera / sfera su / volo

soffitto / alto flat

alto & alto side

sospeso / aura / sfera / volo:

COLOR (Sensor off)
adjustable color temperature (4 steps)
trailing-edge phase cut dimming possible

PRESET (sospeso / aura / volo)
adjustable color temperature (4 steps)
adjustable up / downlight ratio (5 steps)
trailing-edge phase cut dimming possible

PRESET (sfera)
color temperature adjustable (4 stages)
light intensity adjustable (5 stages)

SENSOR

»touchless control« (gesture control)
switching, dimming, up / down fading*
»color tune« (color temperature continuously adjustable)
no external dimming possible

*not with sfera

soffitto / alto / alto side:

COLOR
adjustable color temperature (4 steps)
trailing-edge phase cut dimming possible

Mito »air« box

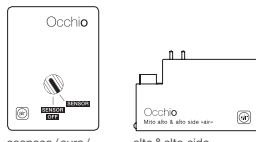

sospeso / aura / sfera / volo

alto & alto side



Occhio air (Bluetooth control using Occhio air app) or air controller (optional) control of individual luminaires, groups and scenes

sospeso / aura / sfera / volo:

SENSOR
»air« + »touchless control« (Bluetooth- and gesture control)
control via »touchless control« and Occhio air app or »air« controller

SENSOR OFF

»air«
control via Occhio air App or »air« controller
switching, dimming, up / down fading »color tune« (color temperature continuously adjustable)



terra / raggio / largo / soffitto / alto flat

terra / largo / raggio:

»air«, »touchless control« and »body sensor« (raggio / terra) (Bluetooth- and gesture control)
control via »touchless control«, »body sensor« and Occhio air App or »air« controller

alto / alto side:

»air« (Bluetooth - control)
control via Occhio air App or »air« controller
switching, dimming
»color tune« (color temperature continuously adjustable)

»ambient light control« (terra)
adjustment to ambient light

»presence sensor« (terra)
presence identification and automatically shutdown by presence sensor

deactivation and adjustable via control and sensor with »air« app

with Mito »air« box no external dimming possible

Mito DALI box (control via DALI)

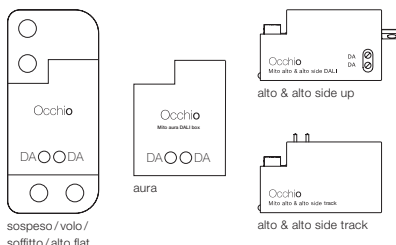

sospeso / volo / soffitto / alto flat

aura

alto & alto side up

alto & alto side track

sospeso / aura / volo:

- color tune adjustable*
- adjust continuously dimming
- up + downlight separate controllable (two DALI addresses needed)
- no »touchless control«, no fading

soffitto / alto / alto side:

- color tune adjustable*
- continuously dimming

* DALI controller DALI Device type 8 (DT8) for controlling of the color tune necessary further signs on www.occhio.com/dali

Mito sospeso 60 fix flat DALI connection diagram

A maximum of 32 Mito sospeso units can be assigned to each DALI circuit.

The Mito sospeso requires two DALI addresses per luminaire, which enables control of the top and bottom sides via their own respective DALI address. The maximum output is reached if both DALI luminaires (top and bottom side) are set to maximum brightness (40 W = 20 W up and 20 W down; 60 W = 30 W up and 30 W down).

The Mito sospeso units can be organized into as many as 16 groups and equipped with an additional 16 scenarios (predefined settings).

Using a DALI short address, they can be actuated and configured individually. In addition, the bi-directional data transfer lets users query the state/status of individual luminaires.

You can find more detailed information at www.occhio.com/dali.

